



Outdoor signboards



Posters

■ Specifications

Item	JV300-130/160	
Print head	On-demand piezo head (2 staggered printheads)	
Print resolution	360 dpi, 540 dpi, 720 dpi, 1080 dpi and 1440 dpi	
Maximum print width	1,361 mm (53.5 in)	1,610 mm (63.3 in)
Maximum media width	1,371 mm (53.9 in)	1,620 mm (63.7 in)
Ink	Type/Color	Eco-solvent ink • SS21 (C, M, Y, K, Lc, Lm, Lk, Or, W) • BS3* (C, M, Y, K) • BS4* (C, M, Y, K) • ES3 (C, M, Y, K, Lc, Lm, W) (*Only available in specific countries) Water-based sublimation ink • Sb53 (Bl, M, Y, K, DK, LBl, Lm) • Sb54 (Bl, M, Y, K, LBl, Lm)
	Package size	SS21 : 440ml Ink cartridge/2L Ink pack (* White is provided in 220ml Ink cartridge only) ES3 : 440ml Ink cartridge (* White is provided in 220ml Ink cartridge only) BS3 : 600ml Ink pack/2L Ink pack BS4 : 600ml Ink pack/2L Ink pack Sb53 : 440ml Ink cartridge/2L Ink pack Sb54 : 440ml Ink cartridge/2L Ink pack *Optional Mimaki bulk ink system 3 (MBIS3) is required for using 2L Ink pack.
Circulation system	MCT (Mimaki Circulation Technology) Only applies to white ink	
Media thickness	1.0 mm or less	
Rolled media weight	40 kg (88 lb) or less	
Certifications	VCCI class A, FCC class A, ETL UL 60950 CE Marking (EMC, Low voltage, and Machinery directive), CB, RoHS REACH, Energy Star, RCM	
Interface	USB 2.0, LAN for E-mail notification function	
Power supply	Single-phase (AC 100-120V / AC 220-240V) x 2	
Power consumption	1440W x 2 or less (100V), 1920W x 2 or less (200V)	
Operational environment	Temperature: 20-30 °C (59-86 °F)	Humidity: 35-65% Rh (Non condensing)
Dimensions (W x D x H)	2,525 x 700 x 1,392 mm (99 x 28 x 55 in.)	2,775 x 700 x 1,392 mm (109 x 28 x 55 in.)
Weight	170.6 kg (376.1 lb)	182.4 kg (402.1 lb)

User friendly RIP "RasterLink 6"

RasterLink 6

- ◆ More beautiful and advanced print results are achieved by following a user-friendly interface that is easy to operate.
- ◆ Color replacement function enhances the ability to re-create printed images.

<Supports Web update function>

- ◆ Program update and profile download can be easily performed via internet.

■ Supplies

Item	Color	Item No.	Remarks	
SS21	Cyan	SPC-0501C	440ml Ink cartridge	
	Magenta	SPC-0501M		
	Yellow	SPC-0501Y		
	Black	SPC-0501K		
	Light Cyan	SPC-0501LC		
	Light Magenta	SPC-0501LM		
	Orange	SPC-0501Or		
	Light Black	SPC-0501Lk		
	White	SPC-0504W-2		220ml Ink cartridge
	Cyan	SPC-0588C		2L Ink pack
Magenta	SPC-0588M			
Yellow	SPC-0588Y			
Black	SPC-0588K			
Light Cyan	SPC-0588LC			
Light Magenta	SPC-0588LM			
ES3	Orange	SPC-0588Or	440ml Ink cartridge	
	Light Black	SPC-0588Lk		
	Cyan	SPC-0440C		
	Magenta	SPC-0440M		
	Yellow	SPC-0440Y		
	Black	SPC-0440K		
	Light Cyan	SPC-0440LC		
	Light Magenta	SPC-0440LM		
	White	SPC-0433W-2		220ml Ink cartridge
	BS3	Cyan		SPC-0667C
Magenta		SPC-0667M		
Yellow		SPC-0667Y		
Black		SPC-0667K		
Cyan		SPC-0693C		
Magenta		SPC-0693M	2L Ink pack	
BS4	Yellow	SPC-0693Y	2L Ink pack	
	Black	SPC-0693K		
	Cyan	BS4-C-60		
	Magenta	BS4-M-60		
	Yellow	BS4-Y-60		
	Black	BS4-K-60		
Sb53	Cyan	BS4-C-2L	440ml Ink cartridge	
	Magenta	BS4-M-2L		
	Yellow	BS4-Y-2L		
	Black	BS4-K-2L		
	Blue	SB53-BL-44		
	Magenta	SB53-M-44		
	Yellow	SB53-Y-44		
	Black	SB53-K-44		
	Deep Black	SB53-DK-44		
	Light Blue	SB53-LBL-44		
Light Magenta	SB53-LM-44			
Sb54	Blue	SB53-BL-2L	2L Ink pack	
	Magenta	SB53-M-2L		
	Yellow	SB53-Y-2L		
	Black	SB53-K-2L		
	Deep Black	SB53-DK-2L		
	Light Blue	SB53-LBL-2L		
	Light Magenta	SB53-LM-2L		
	Blue	SB54-BLT-44		440ml Ink cartridge "ECO PASSPORT" Certification Ink
	Magenta	SB54-MT-44		
	Yellow	SB54-YT-44		
Black	SB54-KT-44			
Light Blue	SB54-LBT-44			
Light Magenta	SB54-LMT-44			
Blue	SB54-BLT-2L	2L Ink pack "ECO PASSPORT" Certification Ink		
Magenta	SB54-MT-2L			
Yellow	SB54-YT-2L			
Black	SB54-KT-2L			
Light Blue	SB54-LBT-2L			
Light Magenta	SB54-LMT-2L			

* SS21 is GREENGUARD Gold certification ink.

●Some of the samples in this catalog are artificial renderings. ●Specifications, design and dimensions stated in this catalog may be subject to change without notice (for technical improvements etc). ●The corporate names and merchandise names written in this catalog are the trademark or registered trademark of the respective corporations. ●Inkjet printers print using extremely fine dots, so colors may vary slightly after replacement of the printing heads. Also note that if using multiple printer units, colors could vary slightly from one unit to other units due to slight individual differences. ●Please note that descriptions and data in this catalog are as of August 2019.



Jugoslovenska 2, 11250 Beograd
 Tel: +381 11 6581274, 6581275
 www.sitotehnika.net
 office@sitotehnika.net



Aerodromska 17, 71000 Sarajevo, tel: +387 33 719095, 66 002600
 Pilanska bb, 78000 Banja Luka, tel: +387 51 305280, 66 002400
 Lagja Kalabria pn, 10000 Priština, tel: +383 38 602080, 45 600641
 Pero Nakov 118-a, 1000 Skoplje, tel: +389 78 290996, 70 862248



For
SIGN
GRAPHICS

Wide-format Inkjet Printer for
Solvent / Water-based Sublimation Inks

JV300series

JV300-130 / JV300-160



New Global Standard
 Outstanding Speed
 Stunning Beauty



New Global Standard

The new standard for highest quality

Outstanding Speed

Maximum printing speed: 105.9m²/h

The JV300-130/160 provides both high productivity and high image quality. The graphs below show the speeds at which the JV300-160 prints in each mode.

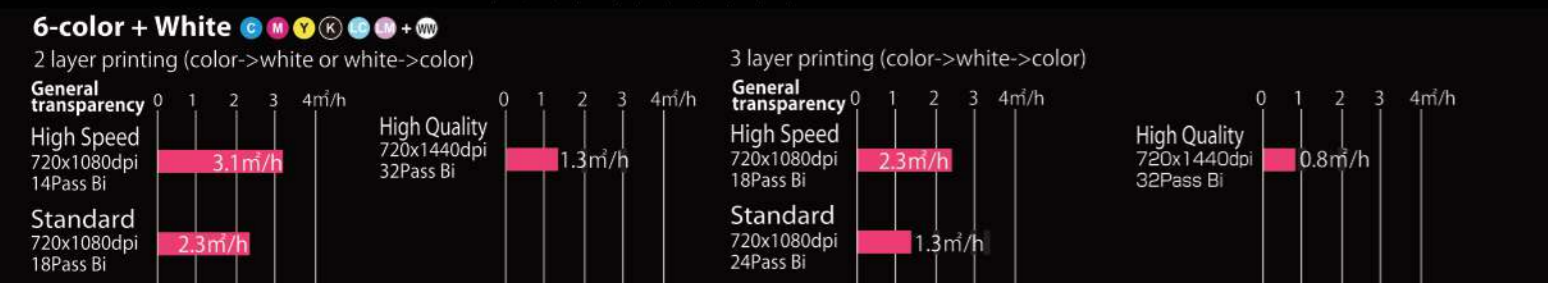
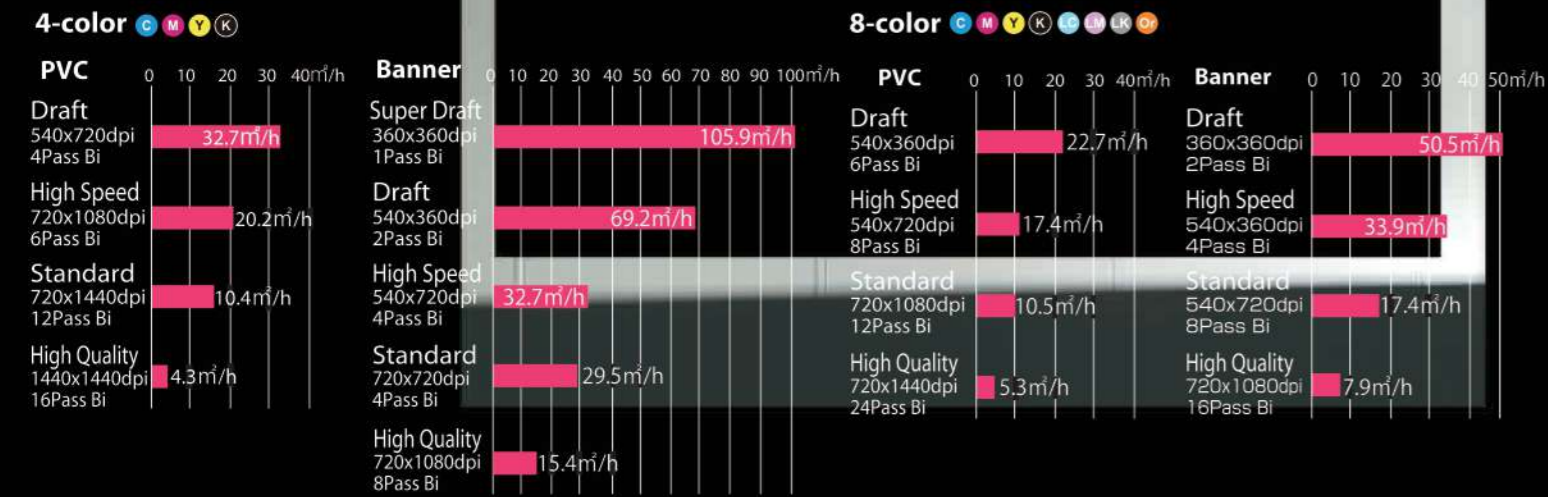

Stunning Beauty

Reduces Banding

Mimaki's original MAPS2 technology, which reduces banding, has evolved further into MAPS3*. Banding is reduced by thinning out the dots and printing over it on areas where banding will be visible.

* MAPS3: Mimaki Advanced Pass System 3

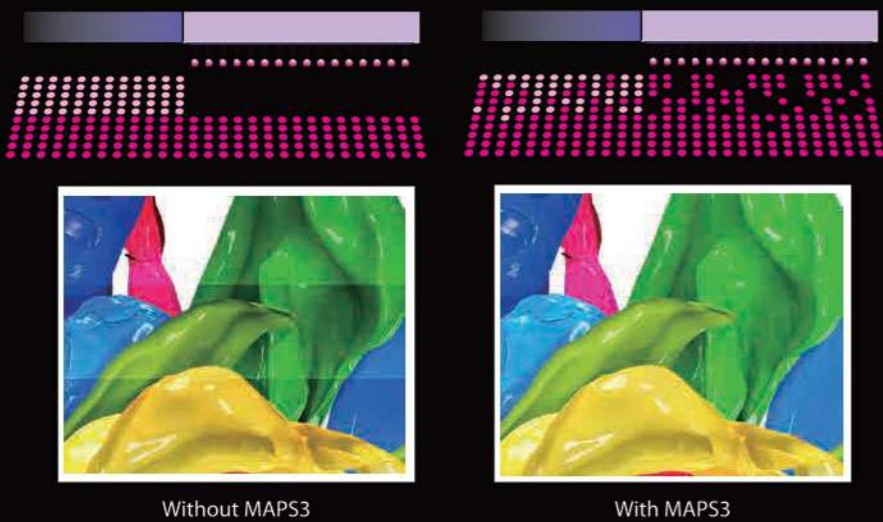

Superior inkjet technology provides consistently high quality imaging

Using Mimaki's original superior inkjet control, the circularity of ink droplets is almost perfect, landing on the media precisely. With the improvement of preciseness in droplet placement, text, lines and edges are printed clearly.

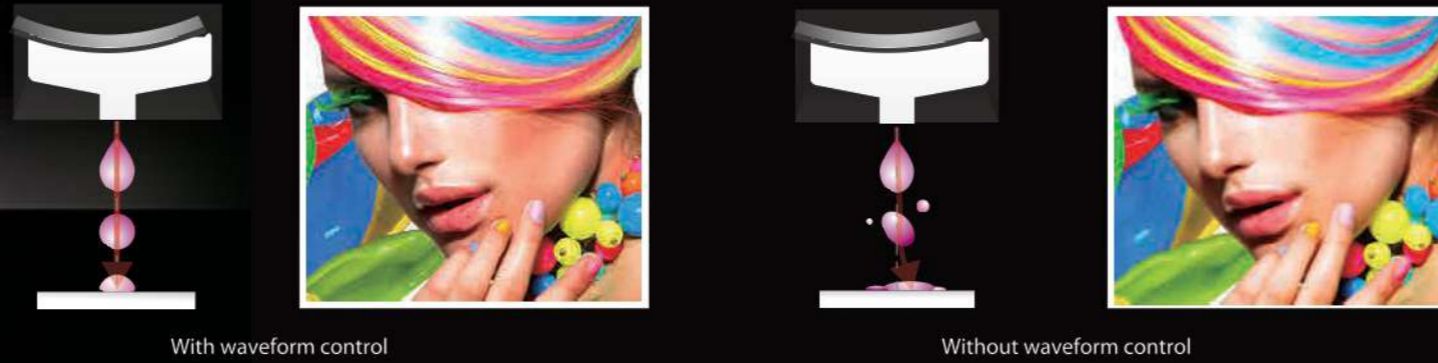

3-Way intelligent heater

A 3-way intelligent heater fixes droplets placed on media. By using Mimaki's original technology in heating the media at a controlled temperature, ink can be fixed while maintaining high color development and high image quality. Thus the JV300 provides both steady color development and easy handling after printing.

- Pre-heater: Heats media to the optimum temperature before printing.
- Print heater: Dries ink after it lands on media before it bleeds, improving color development.
- Post-heater: Enhances ink drying and achieves stable take-up.
- Top blower: Air blower supports drying of ink.

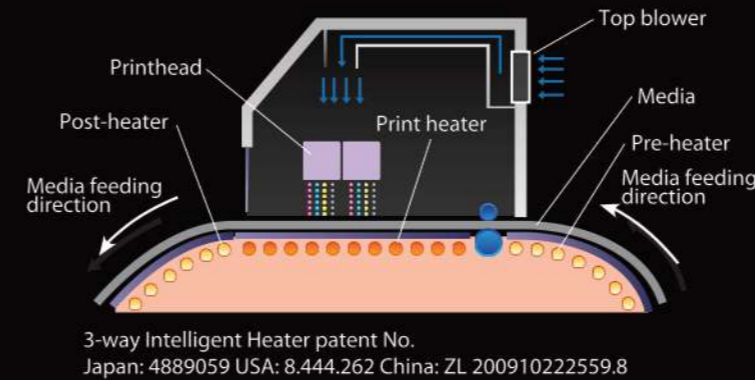

Smooth color gradation printing

By ejecting 3 different dot sizes (Large/Medium/Small), images are expressed smoothly without graininess, even in large-format printing. Furthermore, the Large dot size is 35pl and by using this size effectively, light and shade can be expressed firmly while using higher printing speed settings.

A Variety of Expressiveness to Inspire Sensibility

Achieves a higher level of expression by using orange ink

Orange ink widens the color gamut and reproducibility, enabling to express food freshness and reproduce accurate corporate colors. This allows the unit to cover about 92%* of the PANTONE color chart. *Cover rate as an approximate color.



Accurate expression with light black ink

Gradation properties of grayscale are enhanced by the adoption of light black ink. In addition to accurate monochrome data reproduction, the unit also improves the expression of subtle color gradations such as human skin, providing a highly accurate expression available.



Can be used with Sb54 sublimation transfer ink

Using Sb54 sublimation transfer ink, which achieves crisp and colorful finishing with high ink density, the JV300 can also be used for sublimation transfer printing on polyester materials, improving profitability through lower ink costs and stable printing.

Reliable, User-Friendly Usability

Continuous operation support pack to minimize downtime

The JV300-130/160 is prepared with the following continuous operation support pack to minimize downtime in case of emergency such as machine failure.

Continuous print operation solutions

The JV300 is equipped with Mimaki's original automatic NCU*. If the clogging is not resolved after cleaning, the JV300 sets the nozzle recovery function automatically and resumes printing. It will not print while nozzle drop out is occurring. * NCU : Nozzle Check Unit

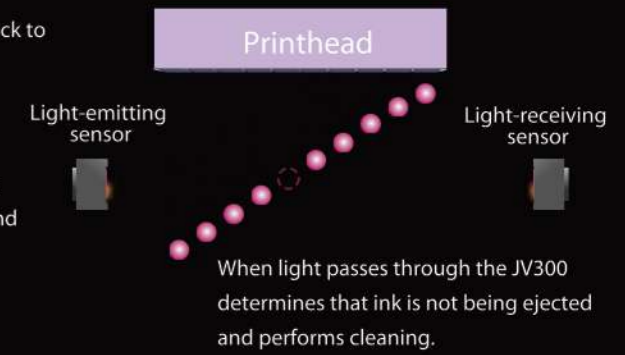

Clears nozzle drop out while maintaining print speed

Because machine is equipped with Mimaki's original NRS*, continuous operation can be performed without affecting print speed, even while the printer is experiencing nozzle drop out. If nozzle drop out is not cleared with maintenance such as cleaning, printing without nozzle drop out is made possible by registering the nozzle that has experienced a drop out**.

- *1 Nozzle Recovery system
- *2 10 nozzles can be registered per nozzle row



E-mail notification to know about print status anywhere, anytime

Using an E-mail notification, the JV300 sends Printer status such as print start/finish and print abort due to an error to a registered E-mail address. This allows users to know the printer status even while they are away.



MCT* ink circulation system provides stable printing

MCT to effectively avoid the settling of white pigment in the ink lines by regularly circulating white ink is standard equipment. It prevents any print troubles and stable printing is assured from the startup time. In addition, MCT contributes to reduction of ink waste and thereby supporting environmentally and economically friendly applications.

*MCT is only applicable to white ink. (MCT = Mimaki Circulation Technology)

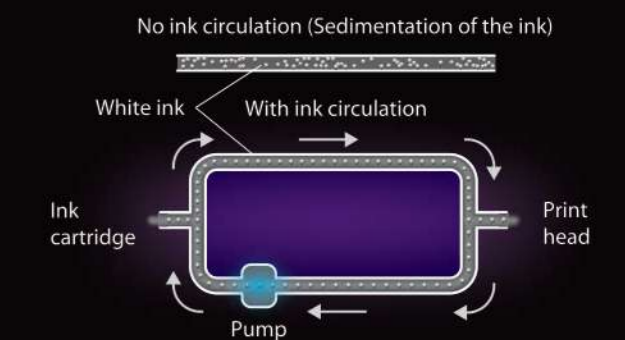

Reliable ink supply system

UISS

The JV300 is equipped with a 2-ink cartridge per color. Even if one cartridge becomes empty, ink supply continues from the other cartridge, preventing print suspension from ink end.

Non-stop ink replacement

Cartridges that are out of ink can be replaced while printing. This prevents print suspension from ink end.

Equipped with MBIS III (Option)

Operating costs can be lowered by continuous printing with a high-capacity 2L ink pack.